

INTERMODAL FACTBOOK

AN INTRODUCTION TO INTERMODAL
FREIGHT TRANSPORTATION



IANA

INTERMODAL ASSOCIATION
OF NORTH AMERICA

TABLE OF CONTENTS

- 1 What is Intermodal?**
- 2 The Intermodal Story**
 - Containerization 2
 - Globalization 3
 - Intermodalism 4
- 5 Why Intermodal?**
- 7 How Does the System Work?**
 - Intermodal Transportation Service Providers 7
 - Intermodal Terminals 8
 - Other Intermodal Facilities 9
 - Equipment Used in Intermodal Transportation 10
 - Containers Identification Systems 12
 - Chassis 14
 - Chassis Provisioning Models 15
 - Common Intermodal Terminal Cargo Handling Machinery 16
 - Specialty Equipment 18
- 19 The Intermodal Association of North America**
 - Structure and Governance 20
 - Committees/Task Force 21
 - Programs 21
 - Education Programs 21
 - Publications 22
 - Intermodal Information Services 22
- 24 Sources and Acknowledgements**
- 27 Appendix**
 - Appendix A: Types of Intermodal Flows 27
 - Appendix B: Standard Intermodal Container & Trailer Types & Sizes 28
 - Appendix C: Intermodal Chassis Components 29

Copyright © 2018, Intermodal Association of North America. All rights reserved. No portion of this document may be copied, reproduced, or transmitted, in any form or by any means, without prior written consent of IANA.



Intermodal Association of North America
11785 Beltsville Drive, Suite 1100
Calverton, MD 20705
301-982-3400
www.intermodal.org



WHAT IS INTERMODAL?

Intermodal freight transportation is the movement of cargo in shipping containers or trailers by more than one mode of transport – ship, rail or truck. Shipping containers are boxes whose standardized design and reinforced securement points allow for seamless handling by a variety of vehicles.

Modern intermodal container shipping and the global intermodal supply chain are relatively new transportation innovations, having only been demonstrated as feasible concepts in the 1950s. The introduction of the shipping container, sometimes called a box, and rapid international adoption of intermodal freight

transportation facilitated the process of globalization and fundamentally changed how the world's businesses conduct trade.

Each year, a fleet of more than 34.5 million containers circling the globe is responsible for moving more than half a billion shipments between shippers and customers worldwide. It is estimated that 95 percent of the world's manufactured goods, at some point, travel intermodally before arriving in the hands of the customer. At more than \$40 billion, the North American intermodal market is the largest in the world.

THE INTERMODAL STORY:

A Brief History of the Transportation Revolution that Changed the World



2

Containerization

Historically, freight cargo moved in individual bags, boxes, crates, drums, barrels and on pallets — now known as break-bulk. Because this type of freight is not uniform, each individual piece of cargo had to be

separately loaded and secured on ships, trains and trucks — an extremely laborious, time consuming and expensive process. The advent of the shipping container would change all this and revolutionize the freight industry.

In the 1950s an innovative trucker, Malcom McLean, set out to improve

the efficiencies of transporting freight with an idea that revolutionized the world. McLean's vision was created on the foundation that it was more efficient to handle one shipping unit — the trailer — versus unloading and reloading its contents

into new conveyances along each step of the cargo's journey to the final customer. He decided to load break-bulk cargo into a standardized truck trailer and then move the entire trailer by truck, train or ship.

McLean worked with other intermodal pioneers to engineer a truck trailer with wheels that could detach from the cargo-filled box. In 1956, his converted WWII oil tanker named the SS Ideal X set sail from Newark, New Jersey to Houston, Texas with 58 of his boxes onboard.

By this time, North American railroads had been experimenting for several years with the commercial concept of piggybacking. This involved truck trailers being driven onto railcars using a circus ramp and then offloaded at rail yards. The term for these ramps traces back to the late 1800's and their early purpose to load traveling circus wagons aboard railcars.



3

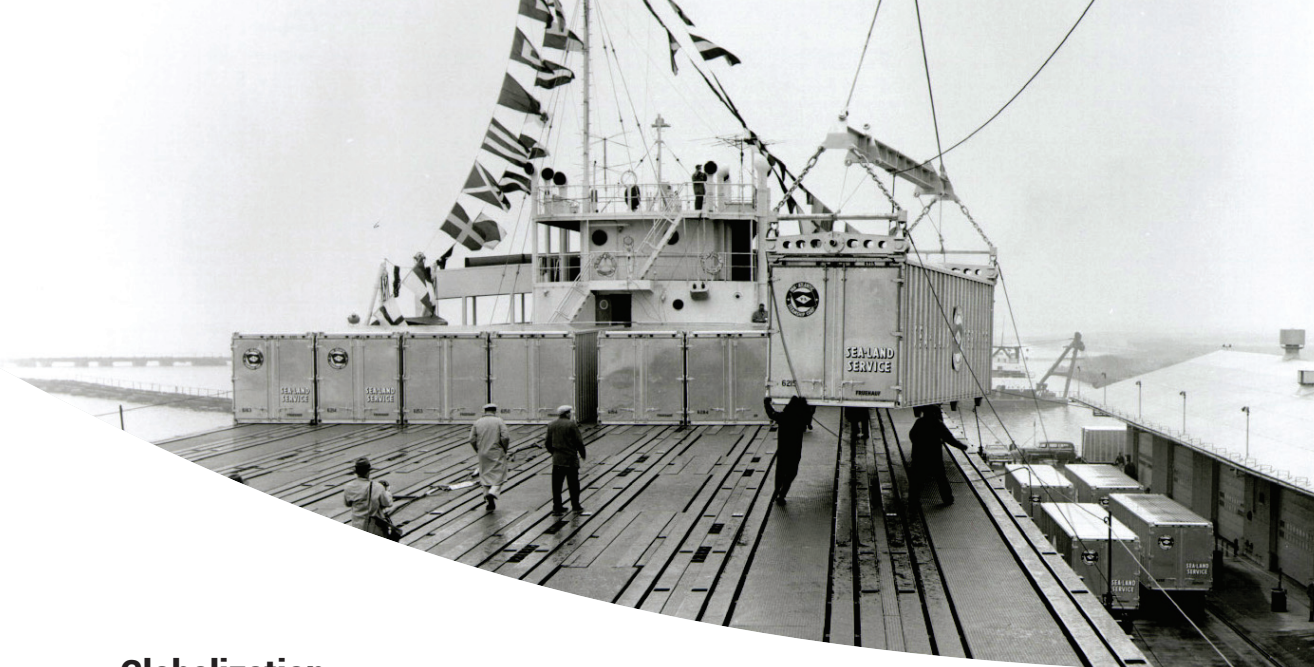

6

Globalization

In order to ensure the compatibility of equipment worldwide, the International Organization for Standardization, or ISO, unified container dimensions, carrying capacity and securement point design into a globally accepted standard. The standardization of intermodal equipment was one of the most important steps to broadening the appeal of containerization on a global scale. In particular, the adoption of the twist-lock and container corner post allowed for nearly universal equipment compatibility.

First developed by McLean's chief engineer Keith Tantlinger, the twist-lock is a device that inserts into a container's corner post and locks the container, sometimes called a box, to chassis, ships, rail cars, handling equipment and other containers. The corner posts, also referred to as corner castings, are reinforced standardized corners used to lift and secure the box to vehicles and other containers. Most containers have eight corner castings, with larger boxes having up to 16 to accommodate a variety of transport configurations.

With a simple turn, the lock is disengaged and the box may be transferred from one vehicle to another. Modern intermodal handling equipment utilizes "automatic" mechanisms that enable the lock to be engaged or disengaged without needing to manually lock all four corners.

Today, international marine containers, sometime referred to as "ISO boxes," come in 20-, 40-, and 45-foot lengths and are most often used in intermodal movements that involve a leg of sea transport. ISO boxes may also be used for the transport of heavier goods, less time sensitive shipments, or movements that would assist in repositioning boxes from the center of the continent back to a port region. The 20-foot shipping container is one Twenty-Foot Equivalent Unit, or TEU, is the globally accepted standard unit used to measure cargo capacity and throughput.

International adoption of the intermodal container and its supporting transport network is often regarded as the key driver of globalization. Throughout the 1980s and 1990s, the finalization of international trade agreements would further reduce the barriers limiting manufacturers from selling goods to consumers around the world.



4



5



7



9



10



11



8

Intermodalism

The introduction of the “box,” as the container is commonly referred to in the industry, has become an important factor in the growth of global trade, because it permits easy handling of the container between numerous transportation modes, shippers, manufacturers and customers. The development of the international shipping container and railroad trailer piggybacking encouraged industry innovation that improved intermodal service, speed and reliability.

This innovation led to the design and development of specialized handling equipment, more efficient ports, larger shipping vessels and advanced mechanized intermodal terminals which could handle thousands of freight containers at any given time.

As container shipments on the railroads increased, the industry introduced new rail cars that accommodated containers to be stacked one on top of each other, providing double-stack rail service. Stack train services have enabled more intermodal freight to be transported on the rails in a more efficient manner, for twice as many containers could now be shipped on a train of the same length, further reducing the cost of moving cargo.

For North American shippers that wanted to take advantage of the combined efficiencies of truck and rail service, but did not require their freight to leave the continent, intermodal piggybacking became a viable option. However, because piggybacking, or the movement of traditional highway semi-trailers that travel by truck and rail, does not allow for double-stacking, North American intermodal service providers eventually introduced domestic containers.

These 48-foot and 53-foot domestic containers are the same size as standard highway trailers and are larger than their ISO cousins. Often, domestic containers may be utilized for the consolidation of the contents of multiple imported ocean containers into one box for final delivery. This process is known as transloading.

Intermodalism and the rise of domestic intermodal have reduced shippers' transportation costs by providing them with an option that offers flexibility, efficiency and reliability. It is predicted that, as demand for intermodal increases in the coming years, carriers and providers will offer new services and products that will further the industry's innovative spirit and continue to revolutionize how the world conducts business.



12

WHY INTERMODAL?

Intermodal freight transportation provides significant benefits for each link in the global and domestic supply chains from the manufacturer, shippers, third party logistics and transportation provider to the end consumer. These benefits include reduced cargo handling, improved security, and reduced damage and loss.

Intermodal allows shippers to load freight into a container or truck trailer with transportation providers only needing to focus on moving one unit of freight rather than each individual piece of cargo within the box or trailer. Eliminating the need to constantly handle the contents of shipping units enables freight to seamlessly flow between various modes of transport, ultimately saving shippers and customers money.

Intermodal is an environmentally friendly approach to moving goods in both domestic and international markets. The ability to utilize the operating efficiencies of ships and rails over long distances with trucks providing the first and last mile of service reduces overall greenhouse gas emissions and allows freight to bypass congested highways.



Environmental Stewardship:

Intermodal provides a more environmentally friendly transportation solution and a reduced carbon footprint. A typical intermodal train is equivalent to 280 truckloads, and can move one ton of freight 470 miles on a gallon of fuel. This translates to fewer trucks on the highways, less congestion and GHG emissions, and fewer accidents.



Cargo Security:

Intermodal's freight loss and damage statistics have steadily decreased over the past 20 years. Since 1995, the loss and damage experienced by Class 1 railroads has dropped by 75%. Intermodal also operates in a more closed-loop environment, where improved security of the cargo results in less thefts.



Cost-effective:

Intermodal provides economies of scale when cost control is critical. Transportation on average amounts to 60+ percent of a shipper's logistics expenses. Intermodal can add capacity through double-stacking while maintaining a fuel efficiency advantage, making it the cost-effective transportation option particularly at distances of 500 miles or more.



13



Service Consistency: Port and marine terminal upgrades, rail line-haul investments and new inland facilities are growing the North American intermodal network and boosting its capacity. The results are increased system-wide resilience, improved and scalable service, and greater origin and destination choices.



Visibility: Technology and the "internet of things" translates into visibility across the supply chain, from origination to last mile drayage. An increasingly interconnected intermodal network and the rapid deployment of information-sharing solutions generate more revenue per mile with shared benefits for importers, exporters and carriers.

In addition, Intermodal helps with overall National Transportation policy. Its infrastructure is largely privately funded and helps address challenges associated with the Highway Trust Fund's ability to support the short and long term needs of our deteriorating infrastructure.

Every year, more than 60 major North American container ports import and export a combined 63 million TEUs which are transferred at marine terminals between ocean carriers and surface transportation modes originating from manufacturers and bound for thousands of inland destinations and millions of consumers. Many of these boxes traveling from or destined for international locations join strictly domestic shipments to account for a total of more than 17 million container and trailer intermodal rail loadings.



14

Consumer, industrial, agricultural and bulk goods including electronics, appliances, refrigerated foods, paper products, clothes and textiles, grain, lumber, plastics, steel and auto parts are only a few of the commodities that take a ride on the steamship lines, railroads, and tractor-trailers that comprise the continent's intermodal network and power North America's economies.

In fact, intermodal is growing faster than any other mode of transportation. Why? Because intermodal combines the best abilities of different transportation modes to deliver service, savings and solutions to shippers.

By working together, third-party logistics providers, trucking companies, railroads, ports and steamship lines are providing a cost-effective, seamless, reliable, efficient, safe and environmentally friendly way to move freight from origin to destination. Throughout the process, intermodal facilitators, or third-party logistics providers, arrange for each piece of the move from pick up to drop off.

HOW DOES THE SYSTEM WORK?

Intermodal Transportation Service Providers

The intermodal supply chain would not work without cooperation from many different service providers.

Motor Carriers are entities that provide truck transportation of freight by means of drayage, truckload or less than truckload.

- A drayage carrier is a motor carrier that provides the road transport leg of intermodal. Because drayage carriers move freight between customer facilities, distribution centers, inland rail hubs and marine terminals, these motor carriers often provide the first and last mile of intermodal service.
- A truckload carrier is a trucking company that dedicates trailers to a single shipper's cargo.
- A less than truckload carrier, or LTL, is a trucking company that transports cargo consolidated from several shippers, and makes multiple pickups and deliveries.

Rail Carriers provide railroad service and the larger national and regional railroads own and operate intermodal terminals, where partner providers transfer cargo between modes. Rail carriers are present at port facilities through on-dock and near-dock service, providing shippers with more efficient routes for imports and exports. In addition to transporting the intermodal chassis and boxes of other providers, some rail carriers own and/or lease their own equipment in order to provide customers with door-to-door intermodal services.

Ocean Carriers, also referred to as **steamship lines**, are shipping companies that operate container cargo vessels. Many ocean carriers are international corporations that facilitate intermodal transportation around the world. These companies own, operate and lease equipment, as well as operate marine terminals through subsidiary entities. Ocean carriers partner with shore-side providers to ensure seamless intermodal transportation service to inland destinations.

Third Party Logistics companies, or **3PLs**, provide multiple logistics services to companies that ship freight. Most 3PLs are considered to be non-asset based companies because, while they arrange for the movement of cargo, they do not own the equipment that is used to move it. Services provided by 3PLs involve the purchase of ocean, rail and/or truck transportation services, and the utilization of equipment from multiple sources. Companies referred to as 3PLs include: intermodal marketing companies, or IMCs; freight forwarders; and non-vessel operating common carriers, or NVOCCs.

Suppliers provide products and services that facilitate business for intermodal service providers. Examples of these companies include, but are not limited to: equipment manufacturers, equipment leasing companies, and technology developers. A list of suppliers can be found in the membership section of IANA's website, intermodal.org.



15



16



17

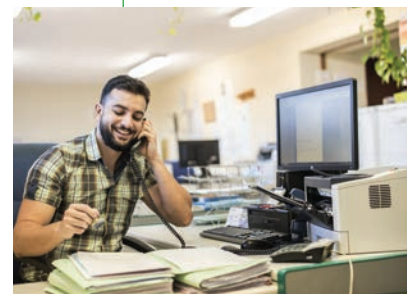

18

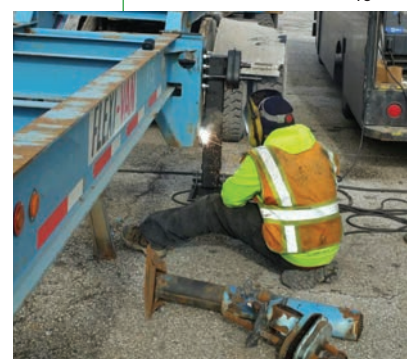

19

Intermodal Terminals

An intermodal terminal is a facility designed for the loading and unloading of containers and trailers to and from flatcars or vessels for movement by sea, rail or road.

Marine Terminal

A marine terminal is an intermodal facility within a port or port area which loads and unloads containers from international oceangoing vessels and/or vessels serving in domestic trades.

The marine terminal accomplishes all the physical and clerical work needed to receive, deliver, stage, store, control and account for the freight in its custody, and interchange marine containers between vessels and trucks. Large

marine terminals may feature on-dock rail service and directly transfer cargo from ship to rail and vice versa.

The dockworkers on a terminal responsible for operating and maintaining equipment and activities related to the handling of cargo are unionized individuals known as longshoremen. A stevedoring firm contracts with a steamship line to hire longshore labor to handle a vessel's cargo and transfer it between the ship and the dock. A marine terminal with the capability to provide rail intermodal service within the facility confines offers on-dock rail service. If a

marine terminal does not have this capability, it may still promote intermodal rail connection provided at nearby intermodal rail terminals often referred to as near-dock rail facilities.

Most marine terminals are located within the confines of a port authority, the governmental public authority responsible for overseeing the transportation activities within a port district. Port authorities function on two distinct types of operating models: operating ports and landlord ports.

- In an operating port model, the port authority builds the wharves and owns the cranes and

cargo-handling equipment. The operating port oversees the activities of the marine terminal by hiring longshoremen to handle cargo directly or through a subsidiary terminal operations arm. Examples of operating ports include: the Georgia Ports Authority, the Virginia Port Authority, the South Carolina Ports Authority and the Massachusetts Port Authority.

- In a landlord port model, the port authority builds the wharves, which it then rents or leases to a marine terminal operator, usually a stevedoring company or the marine terminal operator arm of a steamship line. The operator invests in cargo-handling equipment, hires longshore laborers to operate machinery, and negotiates contracts with ocean carriers to handle the unloading and loading of vessels. Landlord ports often have multiple marine terminal operator tenants, each with their own facility. Examples of landlord ports include: the Port of New York and New Jersey, the Port of Los Angeles, the Port of Long Beach and the Northwest Seaport Alliance.

Rail Terminal

A complex where trailers and/or containers are loaded/unloaded on railcars and interchanged between trains and trucks.

- Wheeled rail terminals are facilities with ample space for storing containers on top of chassis.
- Terminals with higher volume densities where space is at a premium may operate under the grounded model whereby containers are stacked upon one another and chassis are stored off-site or in a designated area.

Intermodal rail terminals may include a rail yard — a complex series of tracks laid parallel to each other for sorting railcars and keeping rolling stock stored off the mainline — as to not obstruct the flow of traffic. In the railyard, railcars are often moved around by specially designed yard locomotives. Though the intermodal rail terminal may have a railyard for lining up cars, the railyard is often a separate operation from the loading/unloading of containers and trailers.



21



22



23

Other Intermodal Facilities

Depot and Container Yard

An intermodal depot or container yard is a storage location for shipping containers. Some depots are recognized by U.S. Customs and Border Protections as locations for processing and inspecting laden containers. Depots and CYs may be located on the same property as a rail or marine terminal, in an adjacent plot or an off-site location. Many depots and CYs are designated by intermodal equipment providers as the location for storage of their empty equipment or for holding of units until receivers can take delivery. These terminals are often the start-stop and storage locations for intermodal chassis pools, and often have vendors that provide both major and minor maintenance and repair services for the equipment.

Inland Port

An inland port is an intermodal facility that is most often part of a larger development or multimodal logistics park designed to encourage economic activity around transportation infrastructure and an inland load center. Inland ports feature direct service to a larger coastal port and even domestic services. Often referred to as “dry ports,” inland ports can be hundreds of miles away from a seaport and may be privately owned commercial facilities or operated in a public-private partnership with a regional governmental entity.

The vast majority of inland ports are intermodal rail terminals located in major heartland metropolitan areas. Examples of inland dry ports include: Centerpoint Intermodal Center, Joliet Illinois; the Midwest Inland Port and Logistics Park Kansas City.

Some inland ports are even co-located on massive logistics properties adjacent to major airports and distribution center clusters. Locations such as Rickenbacker Global Logistics Park; the Charlotte Regional Intermodal Facility; and the Port of Huntsville International Intermodal Center offer opportunities for shippers to combine intermodal service with air freight.

Another type of inland port may be located on an inland waterway and connected to a larger coastal port by a barge and tugboat service. A few inland ports on the Great Lakes feature direct vessel services. Examples of inland river and lake ports include: The Port of Virginia Richmond Marine Terminal; the Port of Lewiston, Idaho; the Port of Albany, New York; and the Port of Cleveland.

Short-haul inland ports may have been developed by a state's port authority to improve intermodal connectivity within the state and provide short-haul rail service or a location for motor carriers to drop off empty containers and pick up equipment. Service to this type of inland port is often marketed to nearby communities by the state's port authority and the terminal operator. The terminal may be owned by the port authority or operated through a public-private partnership. Examples of inland short-haul ports serving a state port authority include: The Port of Virginia Inland Port, the Georgia Ports Authority Cordele Inland Port, the South Carolina Ports Authority Inland Port Greer, and the North Carolina State Ports Authority Piedmont Triad Inland Terminal and Charlotte Intermodal Terminal.

Equipment Used in Intermodal Transportation



25



26

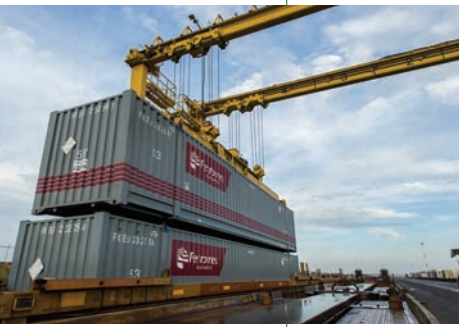

27



29

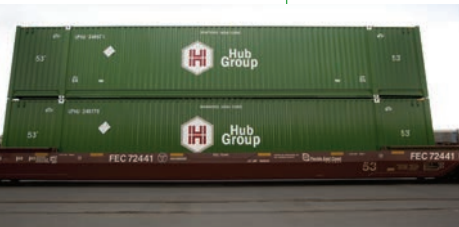

30

A truck tractor is a heavy-duty motor vehicle with a powerful engine and a driver's cab, designed for hauling a trailer. The trailer is attached to a fifth wheel coupling. A tractor without a load is referred to as a bobtail.

A semi-trailer is a 48- or 53-foot unit towed behind a truck tractor that carries freight. A smaller 28 or 28.5-foot trailer that may have two units joined and towed by a single truck is known as a pup.

A tractor-trailer is the combination of a truck tractor and semi-trailer.

A chassis is a rectangular trailer with twist-locks that provides the framework on which a shipping container is attached for road transport. Chassis come in a variety of sizes and configurations depending on the weight and length of the container. They are owned by leasing companies, motor carriers, railroads, shippers and some steamship lines.

An intermodal shipping container is a rectangular piece of equipment similar in design to the semi-trailer, but without wheels. Because it has no wheels, it is often referred to as a box. A container is also designed to withstand loading/unloading of cargo, shipping, storage and handling by more than one mode of transport. International ocean containers come in 20-, 40- and 45-foot lengths. Domestic containers are larger, in 48- or 53-foot lengths. High-cube containers come in the same lengths; however, they are 9'6" tall rather than the standard 8'6".



28

A locomotive is the transport vehicle that provides power to a freight train. It is common for several locomotives to be attached to a very long intermodal train.

A flatcar is a standard piece of rail equipment that can transport a variety of freight configurations including heavy containers, trailers or a combination of both. However, a flatcar is capable of only carrying one row of containers at a time. In order to carry a trailer, a flatcar must have a fifth wheel to secure the trailer's hitch or king-pin. Modern lightweight flatcars designed to transport both containers or trailers are known as spine cars. The terms container on flatcar, or COFC, and trailer on flatcar, or TOFC, are commonly used to describe the type of intermodal train.

A well car is a piece of railroad equipment with a lower deck used for double-stack container shipments. In double-stack configuration, the train is extremely efficient as it is able to carry twice as much freight as a COFC train of the same length.



31

A fully cellular container vessel is a ship specifically designed to efficiently store freight containers throughout the entire structure. The vessel's design includes cellular guides within its cargo holds to line up the four corners of containers on top of each other. The largest container vessels can carry more than 19,000 TEU.

A geared container vessel, also referred to as a lift-on/lift-off vessel, is a ship equipped with its own cranes for handling containers. These vessels are generally smaller than fully cellular container vessels. They are more flexible in the ports they visit as they do not require pierside cranes to load and discharge containers.

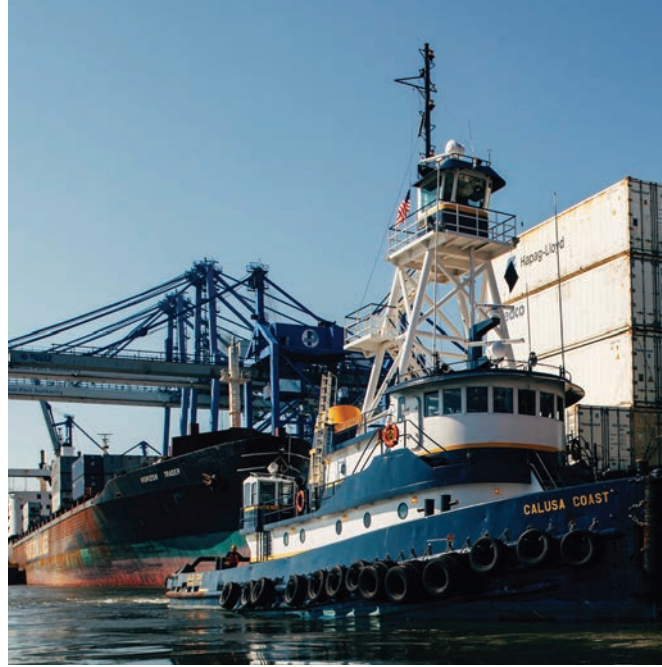

34

A ConRo vessel is a combination container and roll-on/roll-off vessel. The area below deck is used for transporting vehicles while the area above secures containers.

A tugboat is a powerful vessel used to tow or push other vessels. Tugboats are used to safely maneuver container vessels when arriving to and departing from a port's marine terminals. Tugboats may also be used to tow or push cargo barges.

A barge is a flat-bottomed cargo vessel without its own form of propulsion that is pushed or towed by a tugboat. When transporting stacked boxes on the inland or coastal waterways, it is referred to as container on barge, or COB. A barge that can accommodate trailers and containers still mounted on chassis is a roll-on/roll-off, or RoRo Barge.



32



33



35

Container Identification System

Intermodal Container Identification Markings

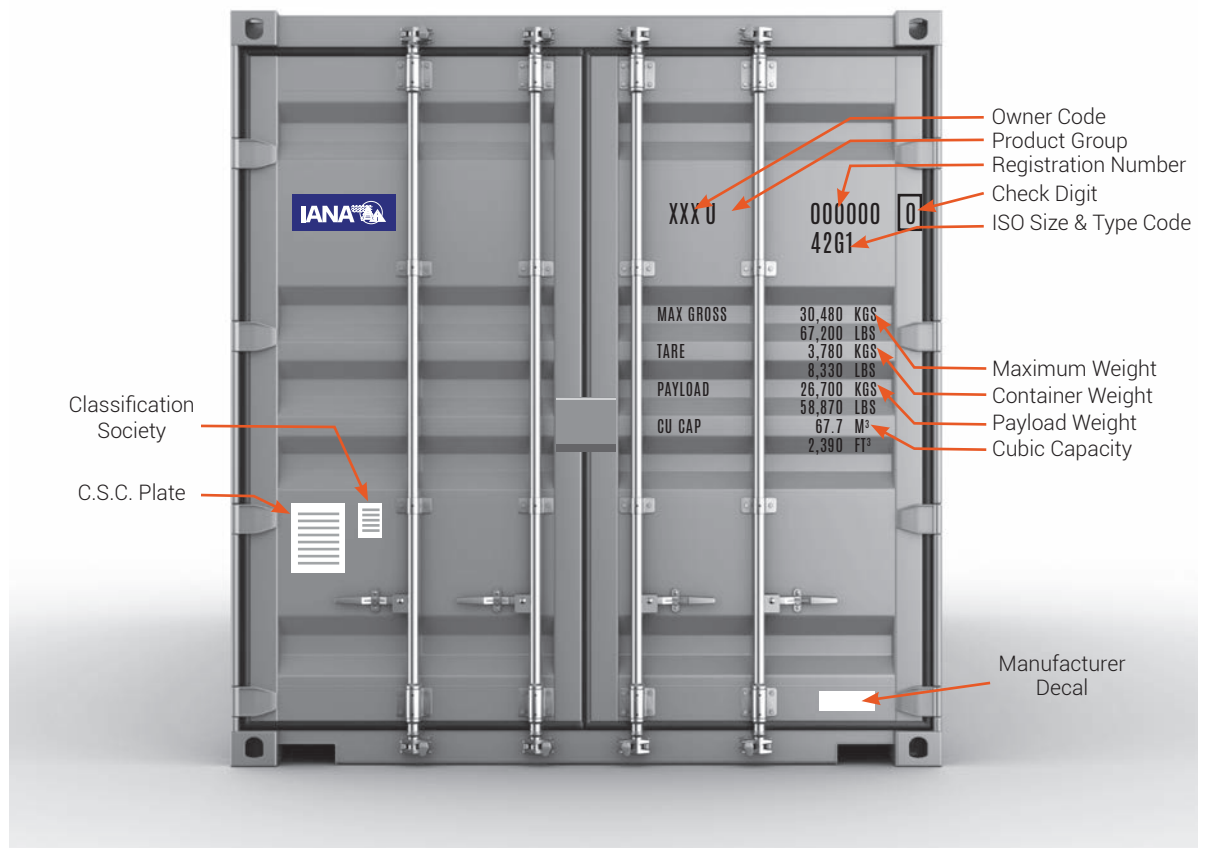

The container identification system is a standardized code composed of a sequence of letters and numbers used to identify international marine, or ISO, and domestic containers. The above photo displays this identification on the top right part of the container:

- **An Owner code** consists of three capital letters that identifies the owner or operator of the container. The Bureau International des Containers et du Transport Intermodal, or BIC, is the international agency that issues owner codes for marine units on behalf of the International Organization for Standardization, or ISO, so that no single code is assigned to more than one owner. For domestic equipment that does not leave North America, this required transportation company identification marking is known as

a Standard Carrier Alpha Code, or SCAC, and is assigned by The National Motor Freight Traffic Association, Inc. A valid registered SCAC is required by registered carriers who participate in IANA's Uniform Intermodal Interchange Facilities Access Agreement, or UIIA. Additionally, many shipping and container leasing companies advertise their logo on the container, so the owner is commonly easy to identify.

- **Product group code** appears right after the owner code and consists of one capital letter, either U – referring to a container, J – referring to equipment that can be attached to a container, such as a power unit, or Z – referring to the chassis used to carry a container.

- **Registration number**, or **Serial number**, is a sequence of 6 digits where each container belonging to an owner has a unique value. Therefore, each owner code can have up to 1 million containers.
- The **Check digit** is a single digit used to cross-verify if the identification sequence is accurate for ISO containers. By convention it is boxed to make sure it is separated and is standing out from the registration number. Since marine terminal gates handle a large amount of containers, there is always a risk that the identification sequence was not correctly inputted. The standard procedure involves the sequence to be remotely inputted by a video camera with the operator entering the sequence manually in the information system or increasingly that sequence being inputted automatically through optical character recognition software. A numerical operation is performed on the container identification sequence

which results in a single digit number, which is then compared with the check digit. If they match, then the identification sequence is accurate – there is still a probability for error, but it is very low. Check digits are only utilized for ISO containers and not found on domestic intermodal equipment.

- **Size and type code** is a sequence of 4 letters or digits that commonly appear right under the container identification sequence. Its provides information about the dimensions and the type of container. The first character is related to the length of the container, the second character is relative to its height, and the remaining two elements of the sequence indicate the container's type and purpose. For example, the size and type code for the world's most common ISO container, a standard 40-foot box, is 42G1. Size and type codes are predominantly utilized for ISO containers and may not be found on domestic intermodal equipment.

Common Size and Type Codes

Length	Height	Type
2 = 20'	2 = 8' 6"	G1= General purpose container
4 = 40'	5 = 9' 6"	"High Cube" R1= Refrigerated container
L = 45'		U1= Open top container
M = 48'		P1= Flat rack/platform container
		T1= Tank container

Operational Characteristics, markings indicating the capacity restrictions of the container are also commonly displayed. They include: the maximum gross weight of the loaded container can carry, the tare or weight of the container equipment, the payload or maximum weight that can be loaded into the container, and the cubic capacity or maximum cargo volume. This

piece of information may not always be posted on the exterior of privately owned domestic intermodal equipment and may be provided to shippers in a different location.

Source: Rodrigue, J-P et al. (2017) Container Identification System, The Geography of Transport Systems, Hofstra University, Department of Global Studies & Geography, https://people.hofstra.edu/geotrans/eng/ch3en/conc3en/container_identification_system.html

Chassis

A durable, reliable and universally interchangeable trailer from which a container easily attaches to for the road segment of its intermodal journey has been fundamental to the rapid adaptation of containerization. This rectangular trailer, known as a container chassis, is a frame with a suspension and axle system, wheels and tires, brakes, a lighting and electrical system, a coupling for towing behind a truck tractor, and twist-locks that provide the securement points to the corner castings on a container. Newly constructed and remanufactured chassis often have high-tech components such as asset tracking, or GPS, weight sensors and automatic tire inflation systems.

Chassis are used for the purpose of container movement by truck between intermodal terminals and shipping facilities such as manufacturing plants, distribution centers and warehouses. Chassis come in a variety of sizes and configurations depending on the weight and length of the container. Chassis may be categorized into three main groups: domestic chassis, ocean or marine chassis, or specialty chassis. These classifications reflect the length and size of the container carried by the chassis.



Domestic Chassis

Domestic chassis are designed to transport 48- or 53-foot containers in the North American trades. The vast majority of the domestic chassis fleet transports intermodal equipment that only interchanges between a road and rail segment. However, select ocean

carriers providing marine service between the continental U.S., Alaska, Hawaii, Puerto Rico and other overseas territories deploy domestic chassis to transport marine domestic sized containers.



38

Ocean or Marine Chassis

Ocean or marine chassis are utilized to transport 20-, 40- or 45-foot ISO marine containers. Some models are structured to accommodate heavy international movements, adjust in length in order to transport containers of different size, or "slide" in order to accommodate the weight restrictions of various states and jurisdictions.



39

Specialty Chassis

Specialty chassis are used to accommodate containers with specific transport needs and to comply with federal regulations. Specialty chassis can include tri-axle and slider units to accommodate heavy shipments, tank chassis for the transport of tank containers, and combination chassis that are capable of transporting containers in multiple configurations.

37

Chassis Provisioning Models

In recent years, the ownership of intermodal container chassis has become a complicated issue due to several shifts in the global maritime industry. Faced with the tough economic environment of the Great Recession, steamship lines began divesting from their

ownership of container chassis around 2008 in order to focus on primary shipping business services. The transition and outsourcing of chassis management has led to the emergence of several container chassis provisioning models in the United States.

Ocean Carrier Chassis Model – Conventional

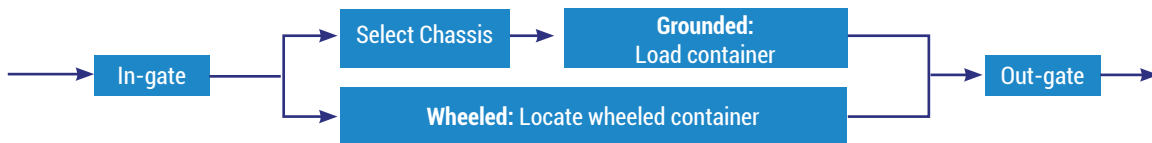

Historically, the steamship line has owned/leased, managed and supplied marine chassis in the United States. This meant that if a truck driver entered a port to pick up a container for carrier X, he or she would also need to pick up a chassis from carrier X.

Motor Carrier or Logistics Company Owned, or Leased, and Operated Chassis Supply Model

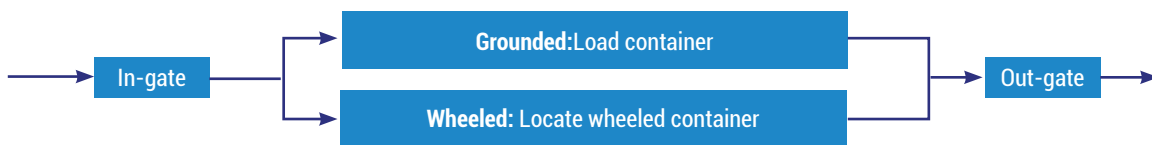

In Canada and Mexico, chassis have been largely supplied by the motor carrier. In this model, the truck driver arrives at the terminal with a chassis he leases or owns, or one provided by his contracted motor carrier or logistics company. In this model, the chassis will normally stay hooked to the driver's truck during loading/unloading when he is dispatched to a terminal for pickup of a container. For example, Old Dominion Freight Line, XPO Logistics and Lowe's Companies utilize owned and leased chassis in some regions.

Regional Cooperative and Alliance Co-op Chassis Pool Supply Model

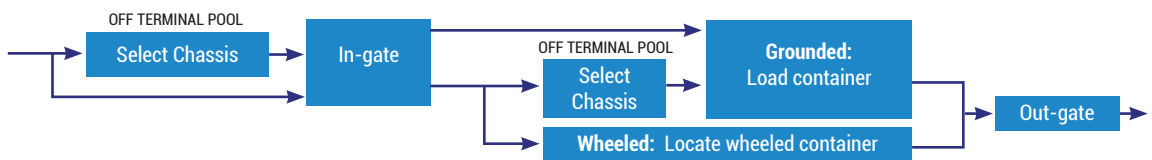

In the 1990s, steamship lines began entering into alliances whereby partner ocean carriers would cooperate on trade routes by sharing services and space, pooling available container slots on their vessels. In order to optimize the allocation of their chassis and minimize terminal capacity issues, steamship lines began to share chassis assets through regional cooperatives, or co-ops, and the alliance co-op chassis pool supply model. In this model, the member contributor companies that own the equipment make joint decisions regarding the pool. The administration of the pool may be handled by a separate professional management company. In the U.S. the group Consolidated Chassis Management, or CCM, is a subsidiary of the Ocean Carrier Equipment Management Association, or OCEMA. CCM independently operates regional pools around the country on behalf of steamship line OCEMA members that contribute chassis.

Neutral Chassis Pool or "Gray Pool" Supply Model

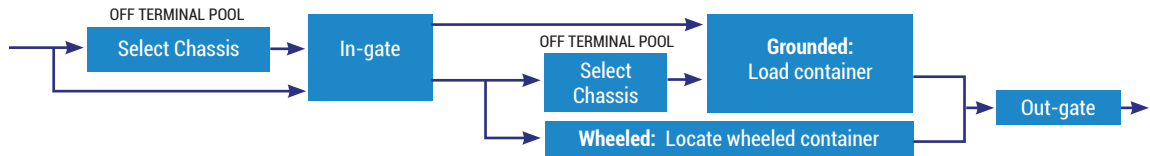

In some regions, third-party chassis leasing companies have developed chassis pools independent of steamship lines and motor carriers. In this neutral chassis pool or "gray pool" supply model, the chassis leasing company owns the equipment and operates the pool by providing responsibility for the equipment, maintenance and repair, insurance, and repositioning of assets based off the chassis' supply and demand. In this model, motor carriers, steamship lines and other customers use a chassis by "renting" the equipment at a daily rate. This allows users to operate individual or multiple chassis without the need to maintain and administer the daily operations of the fleet. Examples of "gray pools" include the Pool of Pools in Los Angeles/Long Beach and the TRAC METRO Pool in the Baltimore, Philadelphia and New York/New Jersey regions.

Terminal Chassis Pool Supply Model

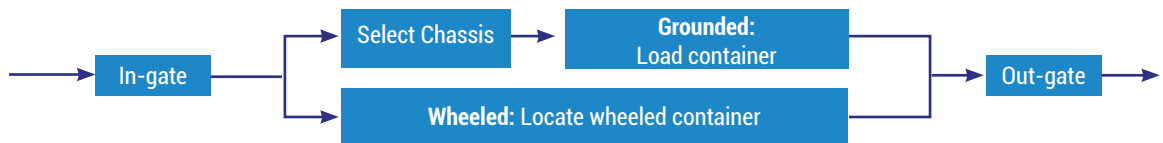

At some intermodal facilities, the terminal operator may offer its own chassis pool as a service to its steamship line, motor carrier, railroad, shipper and logistics company customers. The terminal chassis pool supply model may be a neutral pool owned by the terminal or a co-op managed by the terminal on behalf of the steamship lines. In this model, the terminal operator is the intermodal equipment provider, or IEP, for U.S. DOT roadability regulatory purposes and operates and manages the chassis fleet. An example of this model is the Hampton Roads Chassis Pool, or HRCP II, which is owned and operated through the Virginia Port Authority's terminal operating subsidiary.

Common Intermodal Terminal Cargo Handling Machinery

Although intermodal terminals may be classified into distinct categories determined by function and type of carrier and vehicle serviced, the actual design and operation of each facility is unique due to numerous characteristics including: facility layout and size; geographical location and proximity to population centers; rail, road, and water access and restrictions; ownership; availability of labor; and customer partnerships and needs. In order to accommodate for complexities influencing the specificity of a terminal's design, industry suppliers offer numerous solutions and various distinct types of equipment that facility

operators may utilize to handle intermodal cargo within a terminal.



40



41

A **yard truck** is a smaller truck tractor used to reposition containers, semi-trailers and chassis within an intermodal terminal, cargo yard, port or warehouse facility. It is also referred to as a yard hostler, terminal tractor, utility tractor rig or shunt truck.



43

A **bomb cart** is a heavy-duty trailer used for quick reposition of containers within some intermodal terminals and ports. Unlike a standard chassis, bomb carts do not have twist locks but have side guides to keep boxes on the unit. Bomb carts are often powered by a hostler or yard truck.

A **spreader**, used by a variety of container handling equipment, is a device that lifts boxes by locking to the casting corners. Spreaders used to move semi-trailers have arms that grip onto reinforced lifting points on the underside of the trailer.

A **ship-to-shore crane**, or STS, is a large crane found at marine terminals used to load/unload ships. STSs are sometimes referred to as portainers.

A **straddle carrier** is a crane truck that loads/unloads railcars and trucks or stacks boxes within the terminal by straddling the container.

A **rubber tire gantry crane**, or RTG, is a crane truck wide enough to straddle multiple rows of containers, trailers, truck lanes or rail tracks.

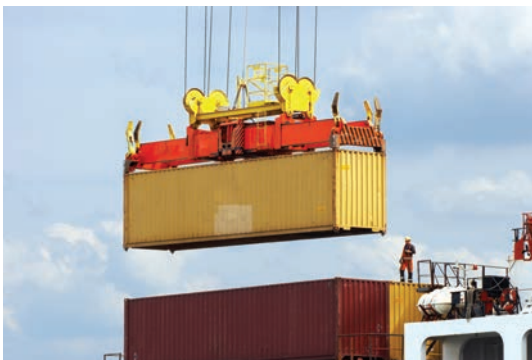

42

A **rail mounted gantry crane**, or **RMG**, is similar to an RTG except it is fixed to rails rather than rubber tires. These cranes are found at some marine and large inland rail terminals. A wide-span RMG is capable of serving multiple rail tracks, truck lanes and container stacking rows at the same time.

A **reach stacker**, also known as a **side-loader**, is a truck with a long boom that allows it to load/unload trucks and rail cars as well as access containers in an adjacent row.

A **container handler** or **top-pick** is a truck that loads/unloads trucks and rail cars and stacks loaded containers by attaching its spreader to the four top corner castings or the underside of a trailer. A container handler stacks empty boxes by only attaching its spreader to two of the top corner castings.

A **forklift** is a basic piece of equipment that is limited to handling only loaded 20-foot containers or empty containers of other dimensions. Forklifts with special attachments may be used to stack chassis in the yard or hook up gensets.

An **automated gate system**, or **AGS**, is a high-tech kiosk that uses high resolution cameras and optical character recognition to improve driver processing time at intermodal terminals.



44



45

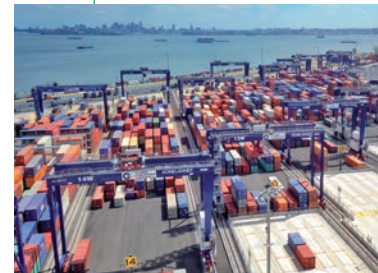

46



47



48

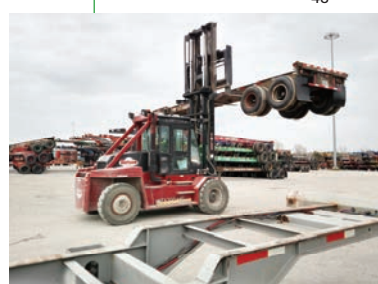

49



50



51

Specialty Equipment

Reefer is a slang term for a refrigerated container that is used to transport temperature or climate sensitive cargo like meat, fruit, vegetables, dairy products, chemicals or pharmaceuticals. Reefer can also refer to a refrigerated trailer.



52

A **genset** is a portable diesel generator used to power a reefer when the box is traveling by road, rail or at a terminal without an electric reefer hook-up. Some designs mount to the front of the container while others attach below the chassis. They are not required on a vessel as the box is plugged into the ship's electrical system.

Reefer rack and plugs refers to the shore based systems that allow reefer containers and trailers to be plugged into a terminal's electrical grid. Terminals with racks and plugs help reduce emissions by removing the need for a reefer to provide its own electrical power through the use of a genset when awaiting pickup.



53

A **tank container** is an intermodal container specifically designed to transport liquids, gases or powders.

Open top containers are intermodal containers without roofs to facilitate the loading of heavy or oversize cargo. Many open tops feature a tarp to protect the freight from the elements.



54

Flat rack containers are used to transport items too large to fit inside a box.



55

THE INTERMODAL ASSOCIATION OF NORTH AMERICA

With the rapid rise of intermodal transportation beginning in the 1950s, the growing industry required a forum to exchange ideas, discuss operational and maintenance issues, and try to solve mutual problems. The pioneering intermodalists recognized the need for the industry's organization across company lines and by the early 1960s formed three trade associations, the predecessors of IANA, which would represent various segments of the intermodal industry.

The National Railroad Intermodal Association, or NRIA, provided a forum for piggyback and container intermodal operators, railroads, truckers, steamship lines and their suppliers to meet and address common industry issues. The Intermodal Transportation Association, or ITA, administered the precursor to IANA's Uniform Intermodal Interchange and Facilities Access Agreement, or UIIA, and facilitated the interchange of trailers and containers between motor carriers, railroads and steamship lines. The Intermodal Marketing Association, or IMA, represented intermodal marketing companies, the freight forwarders and agents of shippers.

In 1990, the leadership of the three organizations began the arduous task of consolidating this group into one association. This association would provide a unified voice for the intermodal freight transportation community in both public and private sectors, as well as provide assistance in the regulatory arena in matters impacting the efficient movement of intermodal freight. It would provide a common ground for the modes to meet to address operational and maintenance responsibility issues that were resulting from freight and equipment being moved by more than one mode of transport. It would also be a repository for the collection of data from the various modes of transport that the industry could use when presenting a united front before Congress and other regulatory agencies.

By the end of 1991, the three organizations merged, and the Intermodal Association of North America was formed. It remains the only freight transportation industry association in North America that represents the combined interests of the intermodal freight transportation community.

IANA Milestones 1991-2016

- 1991** NRIA, ITA, IMA sign merger documents to form IANA
- 1991** Publishes inaugural IANA *Intermodal Insights* newsletter
- 1992** First IANA Annual Conference held in Orlando, Florida
- 1994** Membership reaches 500
- 1995** Agreement with Georgia Freight Bureau to jointly manage the International Intermodal Expo
- 1995** Holds first Intermodal Operations & Maintenance Seminar
- 1995** Launches intermodal.org website
- 1997** Publishes inaugural Rail Intermodal Terminal Directory
- 2000** Obtains sole ownership of the International Intermodal Expo
- 2002** Releases first issue of *Intermodal Market Trends & Statistics* publication
- 2004** *Intermodal Driver Database* debuts
- 2006** Membership reaches 750
- 2007** Initiates IANA Scholarship Program
- 2007** Intermodal EXPO celebrates 25 years
- 2009** Launches GIER to facilitate industry's roadability compliance
- 2011** Launches *Intermodal Marketplace* online buyers guide
- 2012** Membership Exceeds 1000
- 2013** Intermodal EXPO celebrates 30 years
- 2014** Introduction of *North American Intermodal Facilities Directory*
- 2015** Scholarship Funds Exceed \$1 Million
- 2016** IANA celebrates 25 years

IANA's mission is to promote the growth of efficient intermodal freight transportation through innovation, education and dialogue.

IANA's vision

- Promoting the benefits of intermodal freight transportation and educating industry stakeholders
- Providing its members with a mode neutral forum to discuss common issues, build consensus, shape policy and develop recommended practices
- Positively influencing and shaping the legislative and regulatory environment in areas that impact the intermodal industry
- Promoting and facilitating efficient business processes through innovation and technologies, while enabling common systems and services
- Delivering excellence through its people, processes, technology and operations

Structure and Governance

The association's membership consists of five divisions: rail, marine, motor carrier, 3PL and supplier. There is also a category of "non-voting" Associate members. This category was established for those entities that do not qualify for membership under the current division structure, but have an interest in the intermodal freight transportation community. Examples of Associate members would be: shippers/beneficial cargo owners, other associations, academic institutions and government agencies.

Membership in IANA is corporate, with each company entitled to one vote in matters and decisions impacting the organization. The affairs of the association are governed by a board of directors which is comprised of 13 members. Two are elected from each of the five divisions, by the division members, with an additional three elected by the entire membership at-large. The board's executive committee consists of a chairman, vice chairman, treasurer and the immediate past chairman. In addition to the board of directors and executive committee, a president and chief executive officer is hired by the board of directors to oversee the daily operation of the organization, and to act as

liaison between IANA and government agencies, including Congress and administrative agencies of the federal government.

Committees/Task Forces

IANA's structure also includes two types of committees: administrative committees of the board and standing committees.

The administrative committees of the board include: Bylaws, Finance, Industry Award, IIEC Appointment, Policy, Scholarship and a Nominating Committee. Only members of the board of directors serve on these committees.

Standing committees of IANA include the Intermodal Interchange Executive Committee, or IIEC; Maintenance and Repair Committee; and Operations Committee. Any member of the association can participate in the standing committees, with the exception of the IIEC, whose consist is determined by the board of directors.

Issues that impact the efficient and safe movement of freight between the modes of transport often present challenges that need to be addressed and resolved. The committee structure provides the impetus for open discussion, and the forum necessary to develop practical solutions to those issues which impact the industry.

The intermodal Maintenance & Repair Committee addresses issues that relate to maintaining intermodal equipment and components in safe, good repair and in roadable/loadable service. Specific focus areas involve inspection, maintenance and repair practices. Also included in committee deliberations are documentation and reporting procedures and requirements.

The intermodal Operations Committee is responsible for fostering better operational practices between intermodal transportation providers to ensure that customers receive the highest level of service. The Committee acts as a facilitator in resolving operational problems between and among intermodal providers — i.e. terminal operators, intermodal equipment providers and motor carriers. Specific focus areas involve terminal efficiencies, intermodal equipment interchange and driver productivity.

Programs

IANA offers numerous products and services developed in response to the needs of the intermodal industry and its members. From technology solutions, to research, analysis and maintenance of industry data and statistics, IANA offers an array of value added services and programs that assist in facilitating day-to-day business processes for those involved in intermodal transportation. These programs focus on the information needs of the intermodal industry in the areas of environmental initiatives, risk management, safety, security and compliance.

Education Programs

Intermodal EXPO is the largest freight transportation event in North America that is focused solely on intermodal. The event features industry dialogue, education, networking and a tradeshow where the industry's products and services are showcased. Intermodal EXPO provides the impetus for all the segments of the intermodal transportation supply chain to gather under one roof to address industry issues, and examine challenges critical to the efficient and safe movement of freight between the various modes of transportation. Intermodal EXPO is held each September and attracts a wide array of key transportation industry decision makers.

The **Intermodal Operations & Maintenance Business Meeting** is IANA's annual spring meeting which focuses on critical issues impacting North American intermodal operations, maintenance and repair. The event features educational industry roundtables, committee and task force meetings, and a supplier showcase.

IANA's **webinars** help members stay abreast latest industry issues and Intermodal Information Services products.

Publications

Intermodal Market Trends and Statistics is a quarterly publication designed to provide a comprehensive, in-depth look at intermodal volume data. The information contained in this report is collected from participating IMCs and railroads and is used to produce recurring snapshots of the intermodal industry by market segment, major traffic lanes and geographical regions.

IANA also produces **Intermodal Insights**, a magazine designed to keep IANA members up-to-date on important events that could impact their day-to-day operations. Intermodal Insights also provides companies with the opportunity to showcase their products and services through advertising.

Sent exclusively to IANA members, **Intermodal Connections** is a biweekly roundup of industry and Association news with links to Intermodal Edge, IANA's thought-leading blog for the freight community.

The **Intermodal Marketplace** is an online buyer's guide that allows users to search for intermodal-related products and by keyword, category or geographic area.

The **Resource Center** provides a web-based portal for educational content, industry information and facts, economic data, and research and reference materials regarding the intermodal freight industry. The Resource Center is an organic project and will grow over time with input from IANA's members, industry stakeholders, and the general public.

Intermodal Information Services

The **Uniform Intermodal Interchange and Facilities Access Agreement** is the only standard equipment interchange contract in the industry that outlines the rules for equipment interchange among ocean carriers, railroads, leasing companies and intermodal trucking companies. IANA administers this contract and provides a clearinghouse for the collection and dissemination of motor carrier insurance information and supporting documentation necessary to meet the program requirements and specific needs of participating equipment providers. The UIIA is utilized for approximately 95 percent of all North American intermodal equipment interchanges.

The **Terminal Feed Service** enables motor carrier interchange status information to be disseminated electronically on behalf of participating UIIA equipment provider subscribers to the majority of intermodal facilities in North America including IPIs, MTOs, container yards and depot. The TFS assists in expediting the cargo interchange process by ensuring that intermodal facilities receive motor carrier interchange status data in a timely and efficient manner.

The **Insurance Agent Directory** is an online tool that allows insurance agents the ability to promote their services to Motor Carriers in the UIIA program as well as other companies that are involved in cargo interchange.

The **Intermodal Driver Database** is a secure web-based system where motor carriers provide and maintain driver identification information required to access specific intermodal facilities. The IDD contains active driver records provided by the majority of motor carrier companies. The IDD helps to increase cargo/unit visibility and theft prevention, while increasing efficiency by reducing vehicle queue times.

The **Global Intermodal Equipment Registry** is a virtual technology solution to meet the Federal Motor Carrier Safety Administration regulations requiring the identification of intermodal equipment and the intermodal equipment provider responsible for maintenance and repair of that equipment. Over 80 percent of the chassis in service are registered in the GIER database.

IANA's **Driver Vehicle Inspection Reporting service** links the Global Intermodal Equipment Registry, the Intermodal Driver Database and the Uniform Intermodal Interchanges and Facilities Access Agreement database to provide efficient access to data needed for DVIR reporting required under the Federal Motor Carrier Safety Administration Regulations.

The **Driver Vehicle Examination Report** web portal and distribution system provides an efficient method for intermodal equipment providers and motor carriers to be notified and receive copies of Driver Vehicle Examination Reports resulting from roadside inspections. An interface between the Federal Motor Carrier Safety Administration and IANA allows the FMCSA to transmit copies of DVERs electronically to IANA. IANA then, via email, notifies and delivers this information to IEPs and motor carriers registered in IANA's DVER web portal. The Bad Order Equipment Status service provides a clearinghouse for equipment status information – bad order, gate hold, release – that allows for standardization of data communication formats, simplification of operating system interconnectivity and streamlining of trading partner information for all participants as it relates to bad order equipment.

IANA's **Gate Control System** assists ocean carriers, railroads and terminal operators to fully authorize motor carrier intermodal equipment interchanges by providing a simple Yes/No UIIA motor carrier validation for both the container and chassis. In addition, the ability to pre-authorize motor carrier/equipment provider interchanges prior to terminal arrival is also available. The Gate Control System integrates into IANA's existing TFS.

IANA's **Street Interchange** application facilitates motor carrier to motor carrier street interchange – load/load, empty/load, load/empty – as well as street turns for both motor carriers and equipment providers under the UIIA. The web portal provides a technology based solution which automatically confirms that the receiving motor carrier has a valid UIIA interchange with the UIIA equipment provider and captures electronically the transfer of liability, damage and indemnification from the originating motor carrier to the receiving motor carrier.

SOURCES

- Bonney, Joseph and Donovan, Arthur. *The Box That Changed the World: Fifty Years of Container Shipping – An Illustrated History*. Commonwealth Business Media.
- DeBoer, David J. *Piggyback and Containers: A History of Rail Intermodal on America's Steel Highway*. Golden West Books
- Levinson, Marc. *The Box: How the Shipping Container Made the World Smaller and the World Economy Bigger*. Princeton University Press.
- Muller, Gerhardt. *Intermodal Freight Transportation*. ENO Transportation Foundation, Inc. and Intermodal Association of North America.
- Paris, Costas. *Hapag Lloyd Swings to Loss on Tumbling Freight Rates*. WSJ. <http://www.wsj.com/articles/hapag-lloyd-swings-to-loss-on-tumbling-freight-rates-1470830164?tesla=y>
- Prince, Theodore. *Intermodal Terminals*. National Center for Intermodal Transportation. [http://www.ncit.msstate.edu/NCIT%20Reports/2008_12_Whit%20-%20Prince%205-20-2013_Intermodal%20Terminals%20\(2ps\).pdf](http://www.ncit.msstate.edu/NCIT%20Reports/2008_12_Whit%20-%20Prince%205-20-2013_Intermodal%20Terminals%20(2ps).pdf)
- Rodrigue, J-P et al. (2017) *The Geography of Transport Systems*, Hofstra University, Department of Global Studies & Geography, <http://people.hofstra.edu/geotrans>
- United Nations Conference on Trade and Development (UNCTAD). *Review of Maritime Transport 2014*. http://unctad.org/en/PublicationsLibrary/rmt2014_en.pdf
- World Shipping Council. *Global Container Fleet*. *About the Industry: Containers*. <http://www.worldshipping.org/about-the-industry/containers/global-container-fleet>.

ACKNOWLEDGEMENTS

Photo #: 1-18,000 TEU Container ship. Courtesy of the Port of Long Beach

Photo #: 2-Break-bulk cargo. Courtesy Maersk Line. Retrieved from: <https://flic.kr/p/c9cUa5>

Photo #: 3-Malcom McLean. Courtesy of Maersk Line. Retrieved from: <https://flic.kr/p/c9cLiY>

Photo #: 4-The first container ship, Ideal-X. Courtesy of Port of New York & New Jersey

Photo #: 5-Straddle carrier and container. Courtesy of BNSF Railway

Photo #: 6-Engaging a twist lock. Courtesy of BNSF Railway

Photo #: 7-Trailers on flat cars. Courtesy of BNSF Railway

Photo #: 8- Intermodal rail terminal. Courtesy of CSX Transportation and CSX Intermodal Terminals, Inc.

Photo #: 9-Tractor with empty intermodal chassis. Courtesy of Direct ChassisLink, Inc.

Photo #: 10-Container ship leaving port. IANA

Photo #: 11- Assembling a double-stack train. Courtesy of Kansas City Southern

Photo #: 12-Double-stack train. Courtesy of BNSF Railway

Photo #: 13-Container ship. Courtesy of Hapag-Lloyd. Retrieved from: https://www.hapag-lloyd.com/content/dam/website/images/press_and_media/photo_library/Kiel_Express_02_print_10x15cm.jpg

Photo #: 14-Intermodal terminal portal. Courtesy of CN

Photo #: 15-Motor carrier. Courtesy of Schneider

Photo #: 16-Rail carrier. Courtesy of Ferromex/Ferrocarril Mexicano, S.A. de C.V.

Photo #: 17-Ocean carrier. Courtesy of Yusen Logistics (Americas), Inc.

Photo #: 18-Third-party logistics provider. IANA

Photo #: 19-Intermodal supplier. Courtesy of Consolidated Chassis Management, LLC

Photo #: 21-Marine terminal. Courtesy of the Port of Long Beach

Photo #: 22-Rail terminal. Courtesy of CSX Transportation and CSX Intermodal Terminals, Inc.

Photo #: 23-Inland port. Courtesy of BNSF Railway

Photo #: 24-Truck tractors. Courtesy of IMC Companies

Photo #: 26-Chassis. Courtesy of TRAC Intermodal

Photo #: 27-Intermodal shipping container. Courtesy of Ferromex/Ferrocarril Mexicano, S.A. de C.V.

Photo #: 28-Locomotive. Courtesy of Florida East Coast Railway, LLC

Photo #: 29-Flat car. Courtesy of Florida East Coast Railway, LLC

Photo #: 30-Well car. Courtesy of Hub Group

Photo #: 31-Fully cellular container vessel. Courtesy of the Port of Long Beach

Photo #: 32-Geared container vessel. Courtesy of Maersk Line. Retrieved from: <https://flic.kr/p/cMQK2f>

Photo #: 33-ConRo vessel. Courtesy of Bo Randstedt/Wikimedia Commons. Retrieved from: https://commons.wikimedia.org/wiki/File:Atlantic_Cartier.JPG#/media/File:Atlantic_Cartier.JPG

Photo #: 34-Tug boat. Courtesy of Columbia Group and Dann Marine Towing, LC. Provided by: jvilla@columbiacoastal.com

Photo #: 35-Container barge. Courtesy of Dave Gingrich/Wikimedia Commons. Retrieved from: https://commons.wikimedia.org/wiki/File:Containers_on_a_barge_in_the_Chesapeake_Bay.jpg

Photo #: 37-Domestic chassis. Courtesy of Florida East Coast Railway, LLC

Photo #: 38-Marine chassis. Courtesy of Consolidated Chassis Management, LLC

Photo #: 39-Specialty chassis. Courtesy of TRAC Intermodal

Photo #: 40-Yard truck. Courtesy of IMC Companies

Photo #: 41-Bomb cart. Courtesy of Jacksonville Port Authority/JAXPORT. Retrieved from: <https://flic.kr/p/qGZ5EC>

Photo #: 42-Spreader. IANA

Photo #: 43-Ship-to-shore crane. Courtesy of Yusen Logistics (Americas), Inc.

Photo #: 44-Straddle carrier. Courtesy of Konecranes

Photo #: 45-Rubber tire gantry crane with trailer. Courtesy of Kansas City Southern

Photo #: 46-Rail mounted gantry crane. Courtesy of Konecranes

Photo #: 47-Reach stacker. Courtesy of Florida East Coast Railway, LLC

Photo #: 48-Container handler. Courtesy of TRAC Intermodal

Photo #: 49-Forklift. Courtesy of Consolidated Chassis Management, LLC

Photo #: 50-Automated gate kiosk. Courtesy of BNSF Railway

Photo #: 51-Reefer. Courtesy of Port of San Diego. Retrieved from: <https://flic.kr/p/cRfGiW>

Photo #: 52-Reefer and gensets. Courtesy of Jacksonville Port Authority/JAXPORT. Retrieved from: <https://flic.kr/p/5UDHYE>

Photo #: 53-Tank container. IANA

Photo #: 54-Flat rack container on chassis. Courtesy of Jacksonville Port Authority/JAXPORT <https://flic.kr/p/e1B1CK>

Photo #: 55-Marine container terminal. Courtesy of South Carolina Ports Authority

APPENDIX A

Types of Intermodal Flows

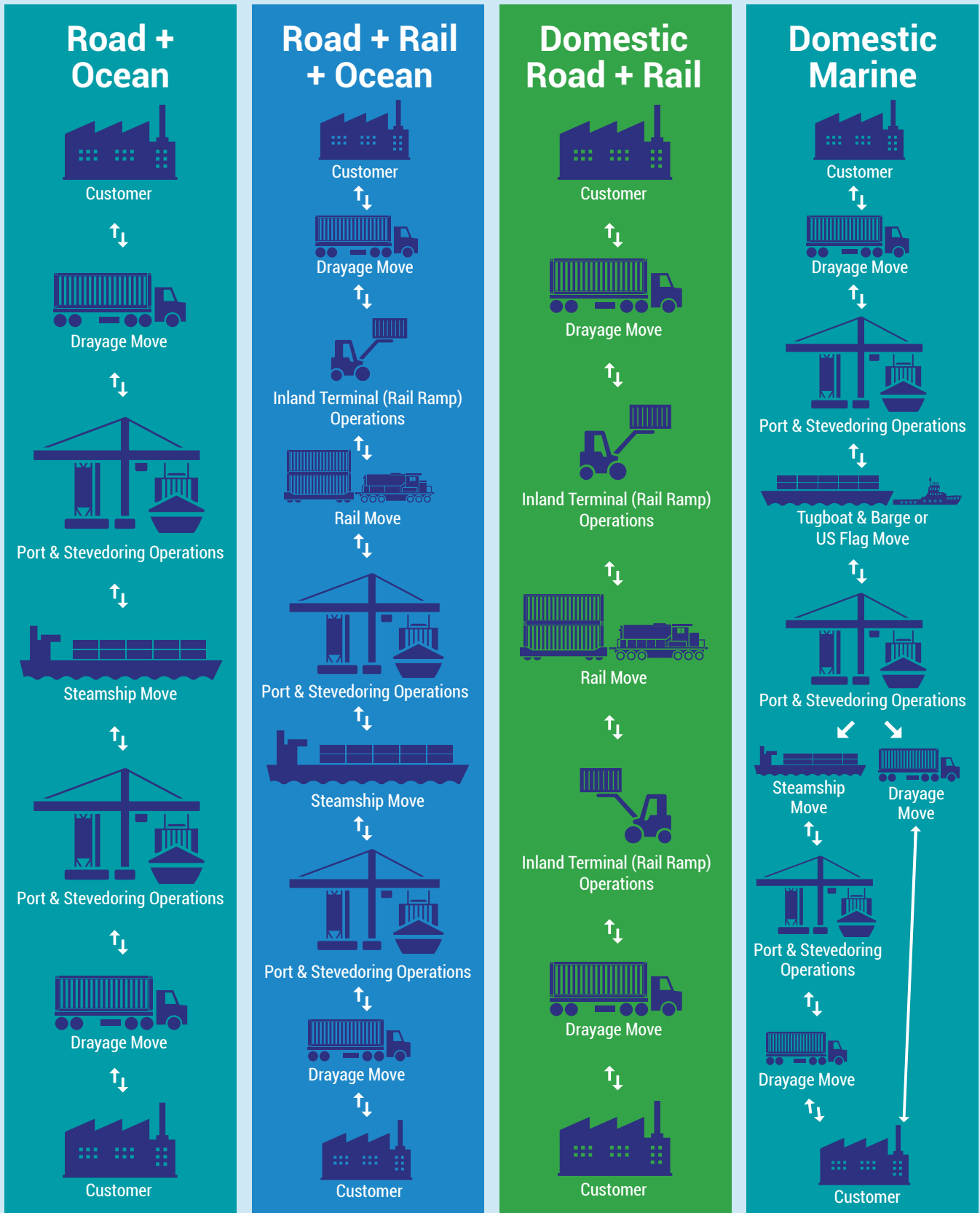

APPENDIX B

Standard Intermodal Container & Trailer Types & Sizes

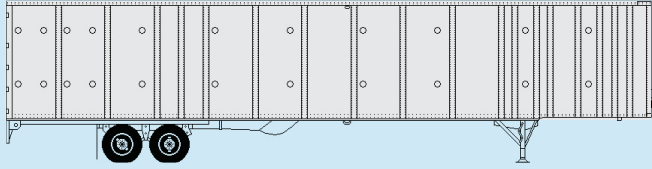

53' Domestic Trailer 4,090 Cubic Ft.

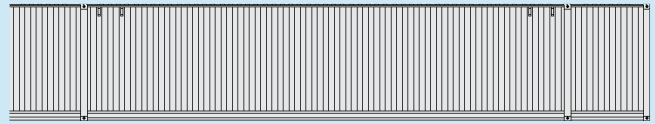

53' Domestic High Cube Container 3,835 Cubic Ft.

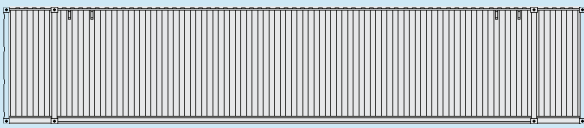

48' Domestic High Cube Container 3,489 Cubic Ft.

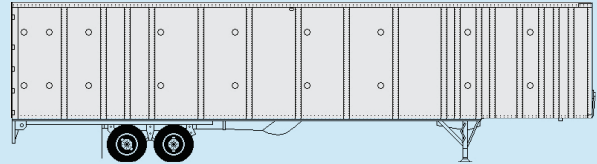

48' Domestic Trailer 3,440 Cubic Ft.

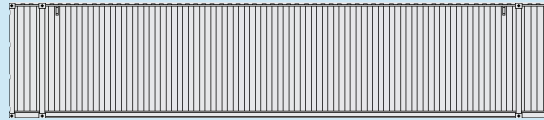

45' Marine (ISO) High Cube Container 3,055 Cubic Ft.

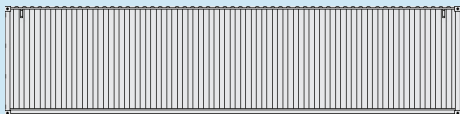

40' Marine (ISO) High Cube Container 2,700 Cubic Ft.

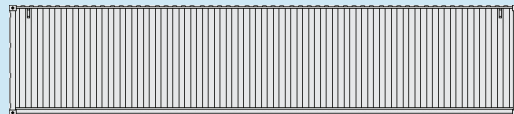

40' Marine (ISO) Standard Container 2,391 Cubic Ft.

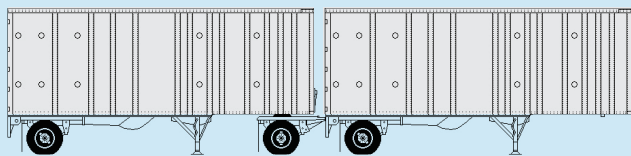

28' Domestic Pup Trailer 2,000 Cubic Ft.

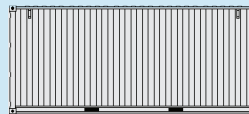

20' Marine (ISO) Standard Container 1,170 Cubic Ft.

Actual carrying capacity may depend upon load requirements and state regulations. These figures are for general information purposes only

APPENDIX C

Intermodal Chassis Components

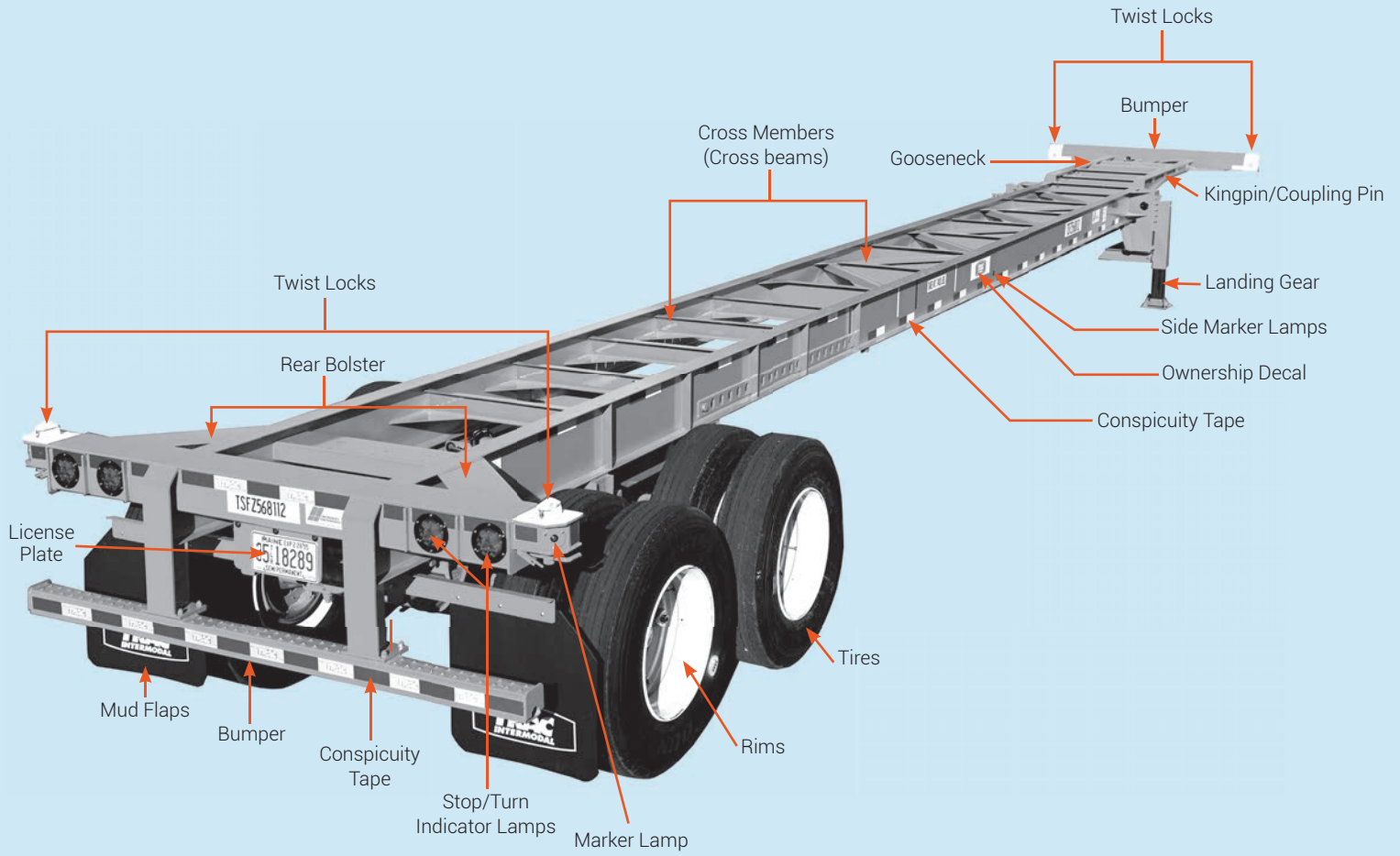



IANA

INTERMODAL ASSOCIATION
OF NORTH AMERICA

Intermodal Association of North America

11785 Beltsville Drive, Suite 1100

Calverton, MD 20705

301-982-3400

www.intermodal.org

